

INSTRUCTIONS

6 FT & 8 FT Backless Portable Bench

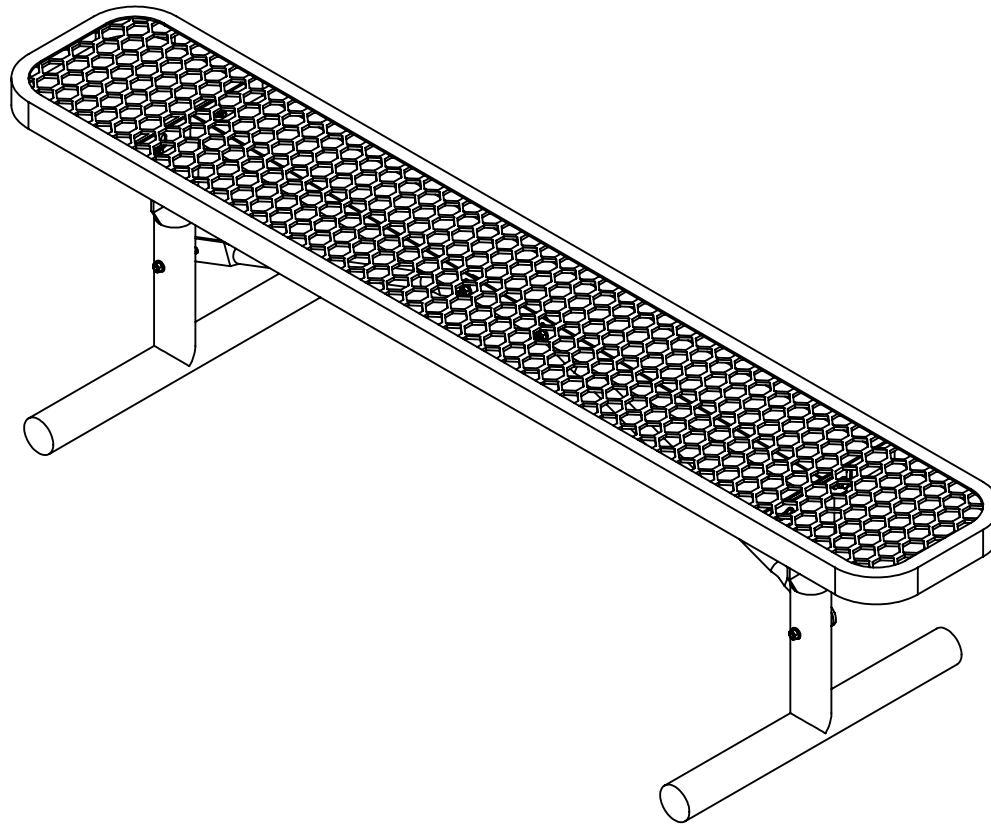

INSTRUCTIONS

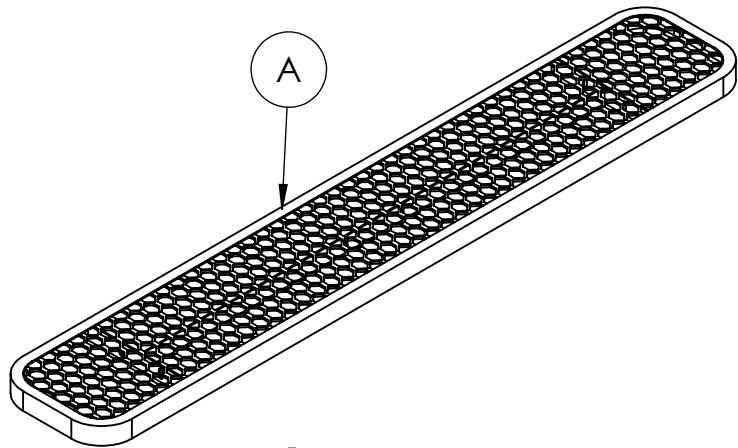

1
Seat

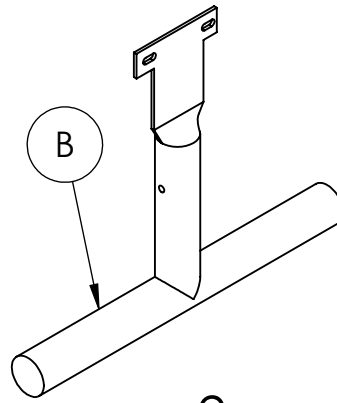

2
Bench Ends

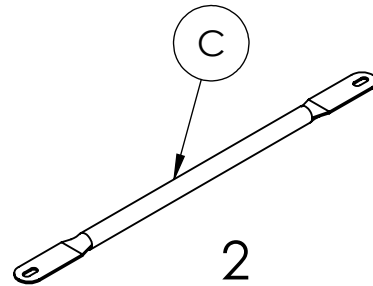

2
Support Braces

HARDWARE

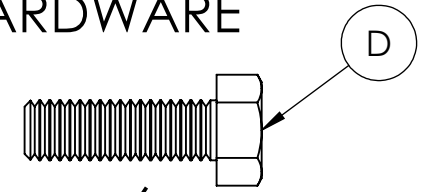

6
M8 x 25
Hex Head Bolts

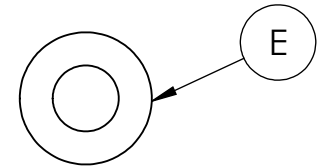

14
M8 Flat Washer

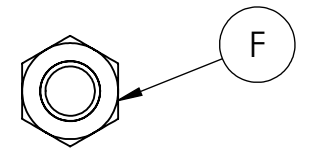

8
5/16" Hex Nut

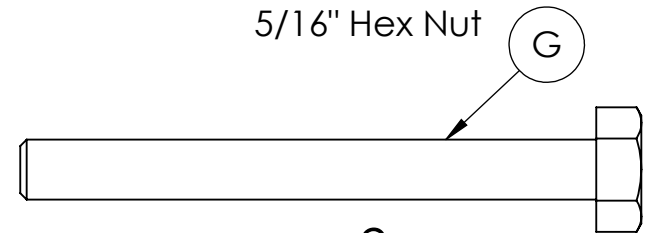

2
M8 x 75
Hex Head Bolts

REQUIRED TOOLS (NOT INCLUDED)

- 1 - 13MM WRENCH
- 1 - 13MM SOCKET

NOTE: IT IS IMPORTANT TO KEEP ALL BOLTS FINGER TIGHT DURING ASSEMBLY UNTIL ENTIRE UNIT IS ASSEMBLED

**HARDWARE &
TOOLS REQUIRED
FOR ASSEMBLY**

2/5

INSTRUCTIONS

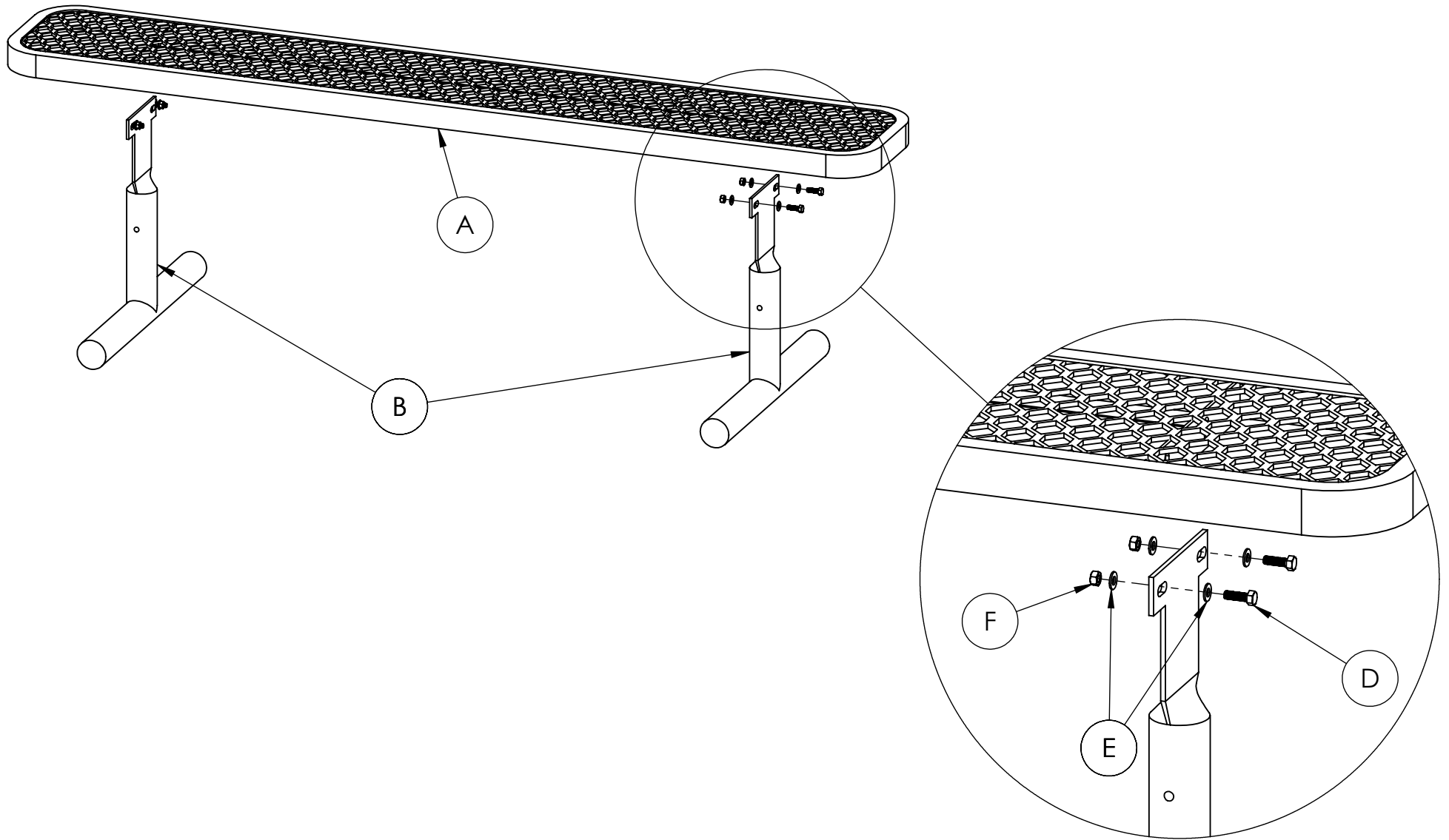

**ATTACH SEATS
TO BENCH
ENDS**

3/5

INSTRUCTIONS

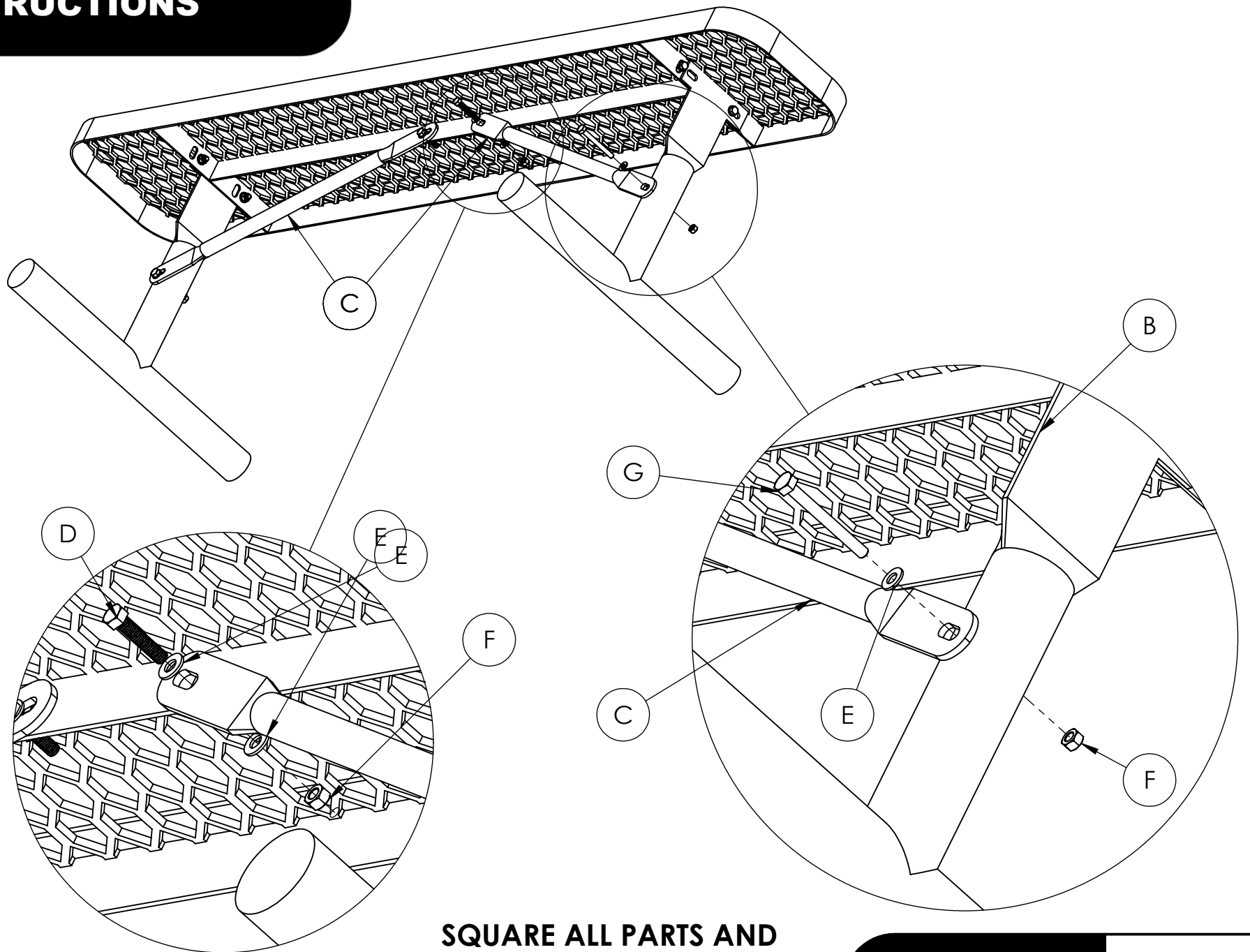

**SQUARE ALL PARTS AND
TIGHTEN ALL HARDWARE**

**ATTACH
SUPPORT
BRACES**

4/5