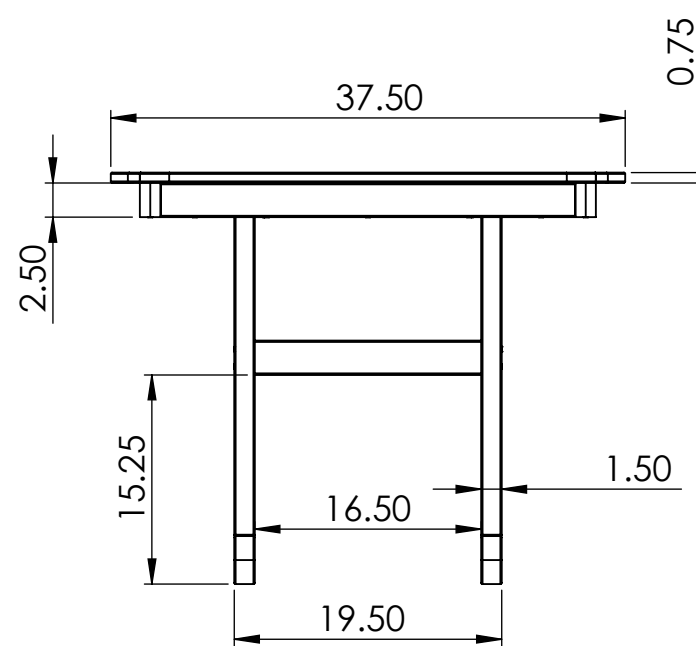
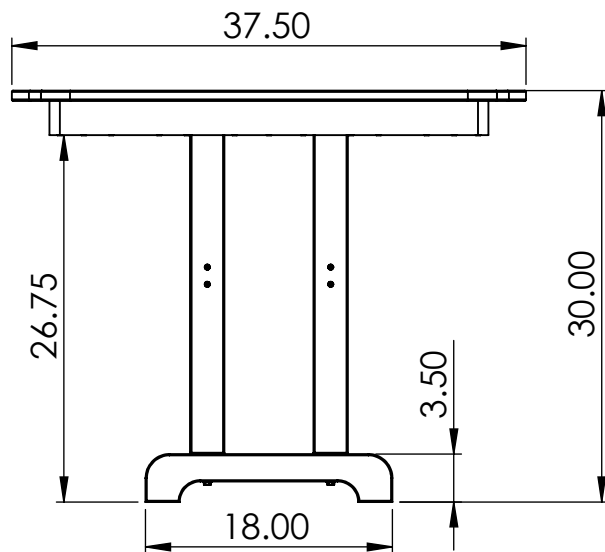
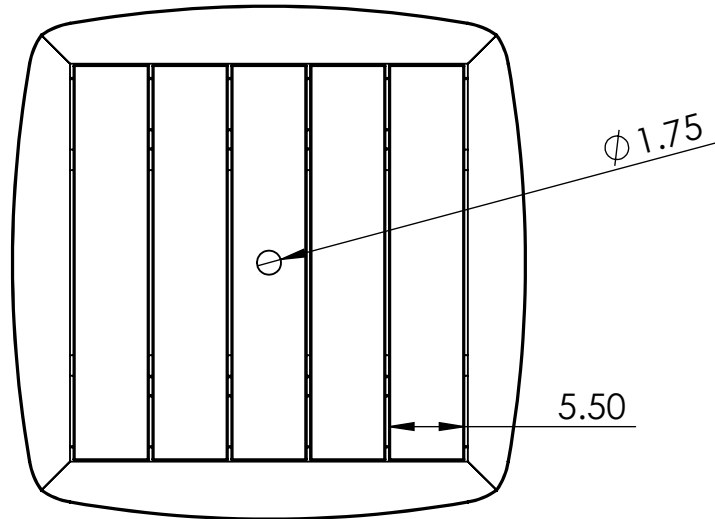
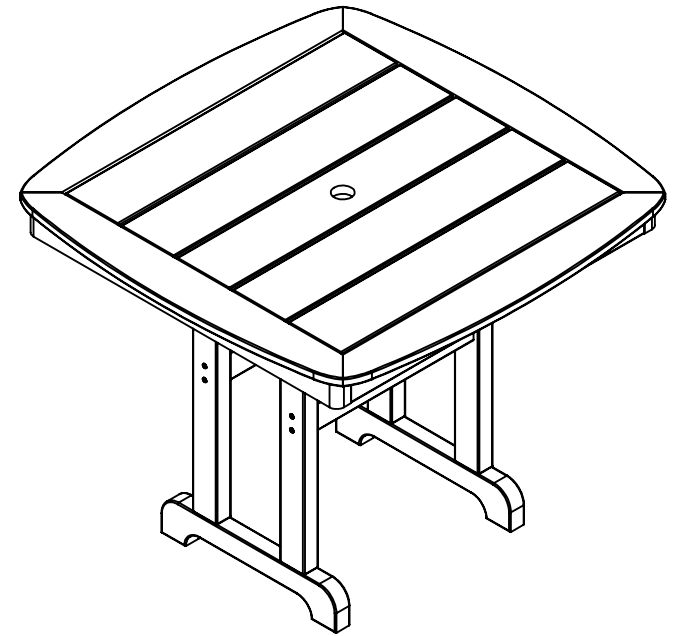

TABLE SPECIFICATIONS

CF1050 REV# 2
7-12-2017



CONSTRUCTION MATERIALS:
Recycled Plastic
HARDWARE:
Stainless Steel

ALL DIMENSIONS SHOWN IN INCHES