

BENCH SPECIFICATIONS BC1635

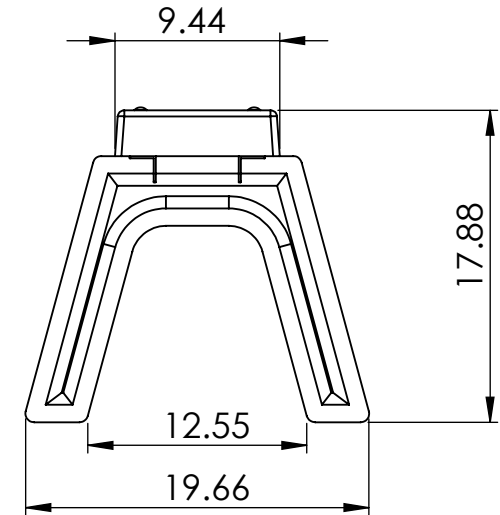
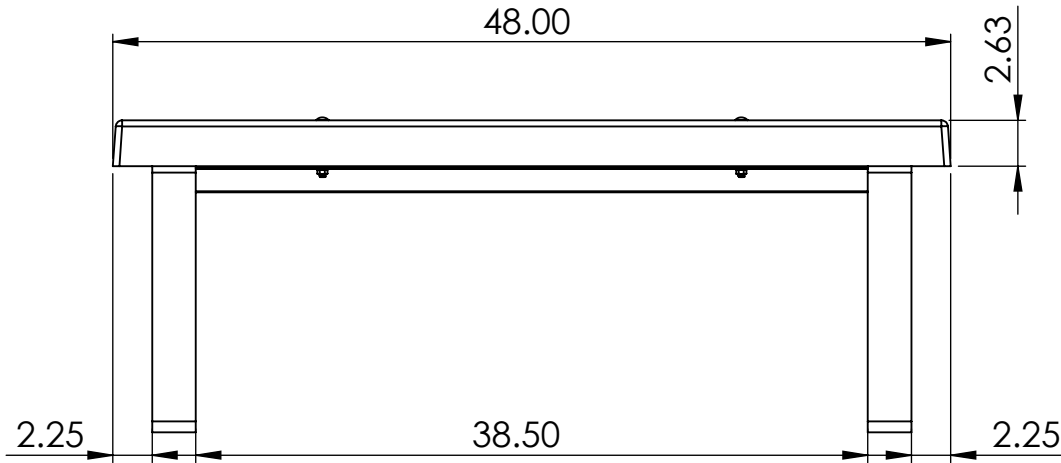
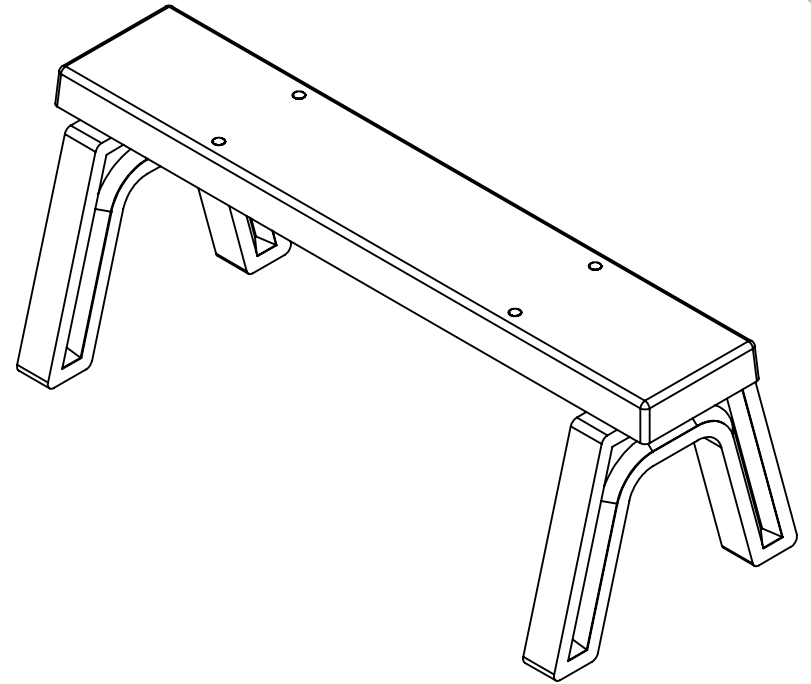
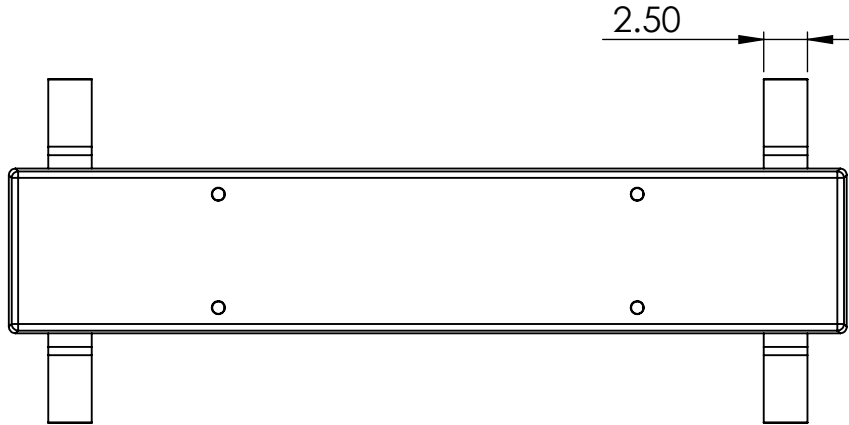

CONSTRUCTION MATERIALS:
Plastic
HARDWARE:
Stainless Steel